



CD150SS  
Shown

## CD100/150

### Pump Volute / Impeller Materials

- CD (AI) – Cast Iron / Cast Iron
- CD (BF) – Cast Iron / Bronze
- CD (SF) – Cast Iron / 316SS
- CD (AB) – Bronze / Bronze
- CD (SS) – 316SS / 316SS
- CD (HC) – Hastelloy C / Hastelloy C

### Features

- **Pump Design** – Compact, close coupled
- **Double Seal** – Type 21 available
- **Teflon Seal** – Type 9 available
- **Flush Options** – Recirculating, Internal, & Quench available

### Applications

- Vapor Degreaser
- Chillers
- Deionized Water Processing
- Filter Systems
- Water Treatment Systems
- Circulation / Filtration

### Optional Configurations

- **Air Motor:** Up to 2-1/2 HP
- **Vertical Mounting:**
- **Power Frame Mounting:**

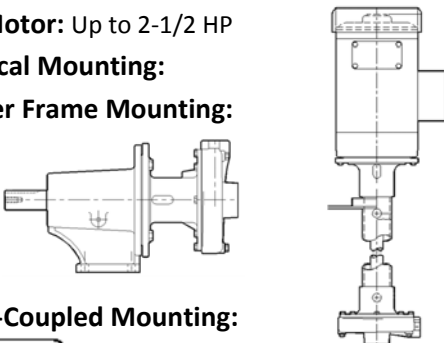

- **Long-Coupled Mounting:**

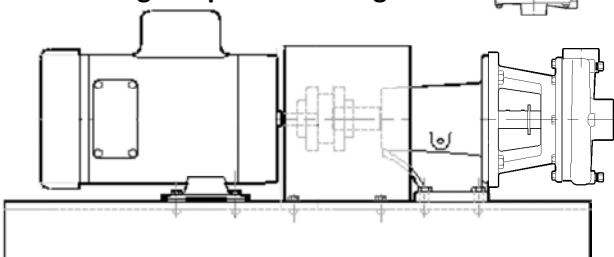

### Standard Specifications

- CD100 / CD100V Discharge 1" FNPT, Suction 1-1/4" FNPT
- CD150 / CD150V Discharge 1-1/2" FNPT, Suction 2" FNPT
- Maximum Impeller Diameter: 4.94"
- Stub Shaft: 5/8" 316SS (7/8" Optional)
- Motor: NEMA C Face (Multiple enclosures available)
- Mechanical Seal:
  - Single, 5/8" Type 6A Buna, Carbon vs. Ceramic (AI, BF, SF, AB)
  - Single, 5/8" Type 21 Viton, Carbon vs. Ceramic (SS)
  - Single, 5/8" Type 9 Teflon, Carbon vs. Ceramic (HC)

*Note: Additional seal options available*

### Performance Curve – 60 Hz

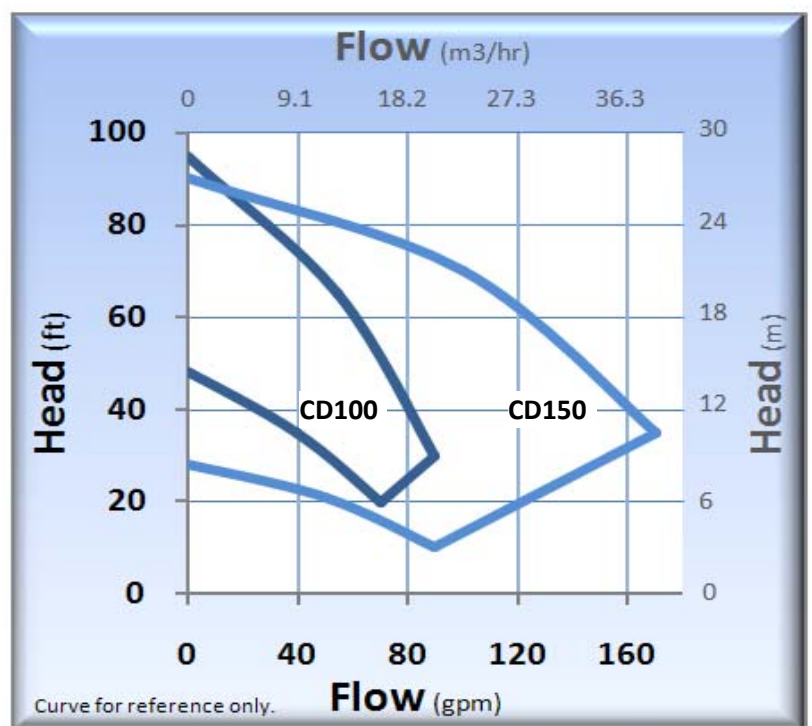

# CD100/150

Technical Information	
Max Flow (CD100)	90 GPM (20.4 m3/hr)
Max Flow (CD150)	170 GPM (38.6 m3/hr)
Max Head	95 feet (29 m)
Min. Flow (CD100)	12 GPM (2.7 m3/hr)
Min. Flow (CD150)	25 GPM (5.7 m3/hr)
Max Solid Size	0.150" (3.81 mm)
Max Working Pressure	(Type 6A Seal) 75 PSI (5.2 bar)
	(Type 8 Seal) 325 PSI (22.4 bar)
	(Type 9 Seal) 350 PSI (24.1 bar)
	(Type 21 Seal) 150 PSI (10.3 bar)
(Type 2106 Seal)	150 PSI (10.3 bar)
Max Temp.	300°F (149°C)*

Materials of Construction						
CD	AI	BF	SF	AB	SS	HC
Volute	Cast Iron	Cast Iron	Cast Iron	Bronze	316SS	HC
Impeller	Cast Iron	Bronze	316SS	Bronze	316SS	HC
Bracket	Cast Iron	Cast Iron	Cast Iron	Bronze	316SS	HC
Gasket**	Syn. Fiber	Syn. Fiber	Syn. Fiber	N/A	Teflon	Teflon
O-ring***	Buna	Buna	Buna	Buna	Viton	N/A
Fasteners	Plated Steel	Plated Steel	Plated Steel	18-8 SS	316 SS	HC

\* Temperature limits will vary according to the liquid being pumped and the sealing materials used.

\*\* Volute gasket is standard on CD100AI, BF, SF, SS, & CD100/150 HC.

\*\*\* Volute O-ring is standard on CD100AB, and CD150AI, BF, SF, AB, & SS.

## Dimensions (CDSS)

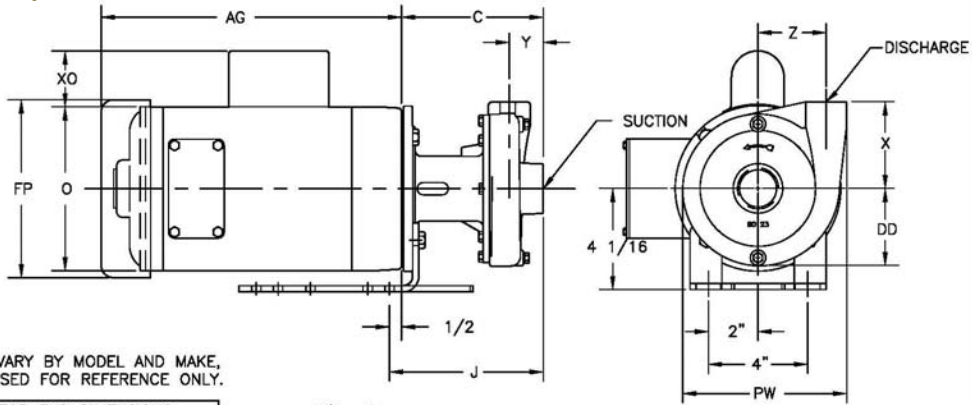

NOTE:  
MOTOR DIMENSIONS WILL VARY BY MODEL AND MAKE,  
DIMENSIONS ARE TO BE USED FOR REFERENCE ONLY.

		MOTOR END DIMENSIONS			
HP	RPM FRM	AG	FP	O	XO
1/4	1800 56C	7 3/4	6 1/8	5 3/8	2 1/16
1/3	1800 56C	8 1/4	6 1/8	5 3/8	2 1/16
1/2	1800 56C	8 3/4	6 1/8	5 3/8	2 1/16
1/3	3600 56C	8 1/2	6 1/8	5 3/8	2 1/16
1/2	3600 56C	8 3/4	6 1/8	5 3/8	2 1/16
3/4	3600 56C	9 1/4	6 1/8	5 3/8	2 1/16
1	3600 56C	9 3/4	6 1/8	5 3/8	2 1/16
1 1/2	3600 56C	10 1/2	7 3/16	6 7/8	2 1/4
2	3600 56C	11 1/8	7 3/16	6 7/8	2 1/4
3	3600 56C	12 3/8	7 3/16	6 7/8	2 1/4

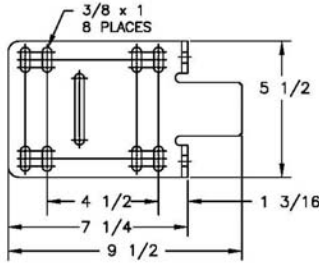

NOTE:  
ALL DIMENSIONS HAVE BEEN ROUNDED TO THE NEAREST 1/8".

		PUMP END DIMENSIONS								
		C	DD	PW	X	Y	Z	J	SUCTION	DISCHG
CD100	SS	5 3/4	3 1/8	6 5/8	3 1/2	1 3/8	2 3/4	6 1/4	1 1/4	1"
CD150	SS	6 13/16	4 1/16	7 15/16	3 13/16	2 1/8	3 1/16	7 5/16	2"	1 1/2"

**PRICE PUMP CO.**

21775 Eighth Street East  
Sonoma, CA 95476-0329  
MAIN (707) 938-8441  
TOLL FREE (800) 345-7867  
FAX (707) 938-0764  
E-mail: [sales@pricepump.com](mailto:sales@pricepump.com)  
Website: [www.pricepump.com](http://www.pricepump.com)

Contact factory for special pump configurations,  
same day, and next day delivery options.

Member of:  
**Hydraulic INSTITUTE**



Rev. Date: September 2010